

CafeRomantica

NICR646

Coffee / Espresso machine
Manual and Tips

GB



NIVONA

A passion for coffee.

1

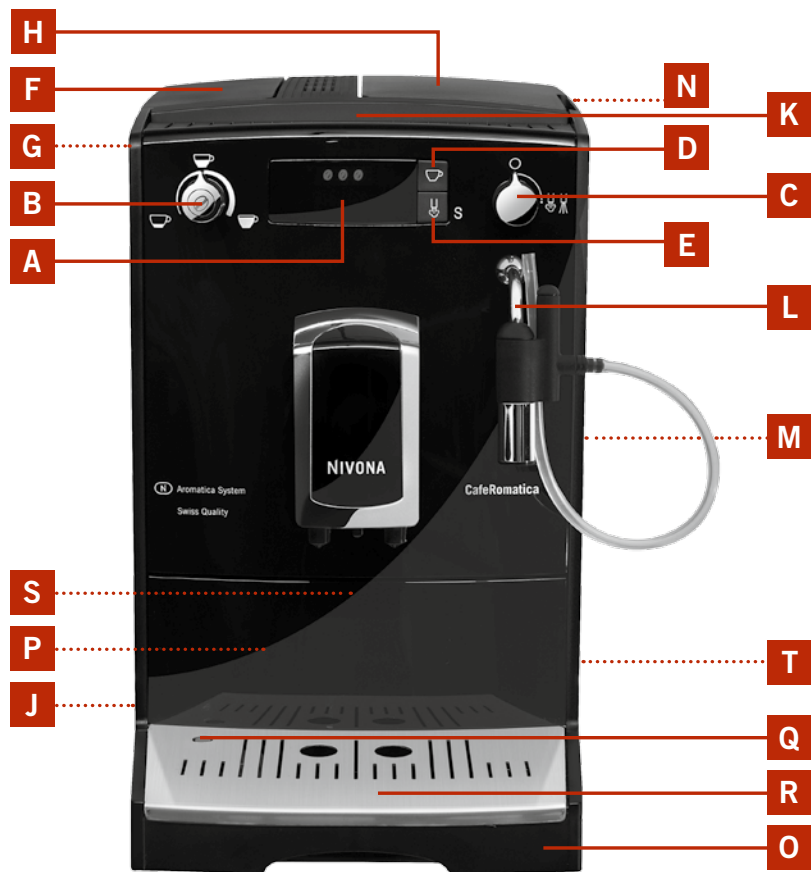

- A** Display
- B** Aroma/volume selector
- C** Steam/hot water control
- D** Coffee button
- E** Steam/rinsing button
- F** Cover for water tank
- G** Water tank
- H** Cover for coffee bean container
- J** On/off switch
- K** Cup rack
- L** Steam/hot water jet, Spumatore
- M** Service door
- N** Lid of coffee powder chute
- O** Drip tray
- P** Used coffee container (inside)
- Q** Water indicator for drip tray
- R** Drip grid
- S** Type label (inside, remove drip tray)
- T** Power cord bay

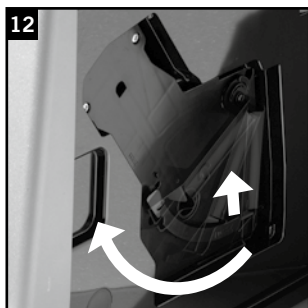
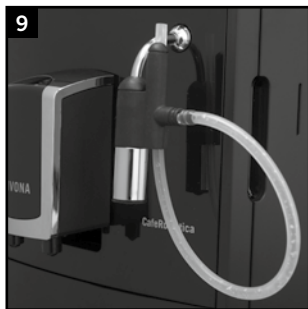
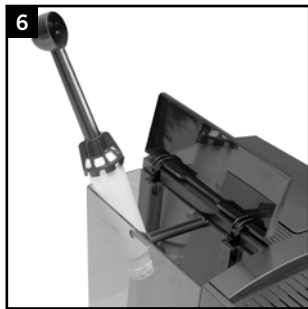
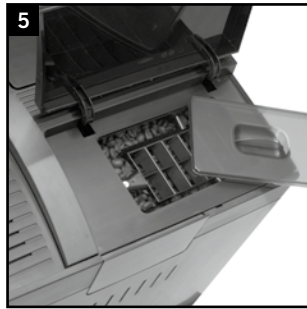
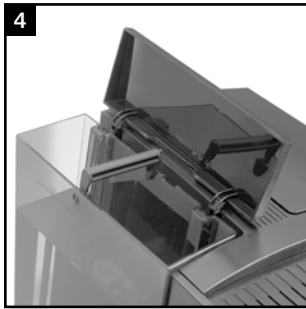
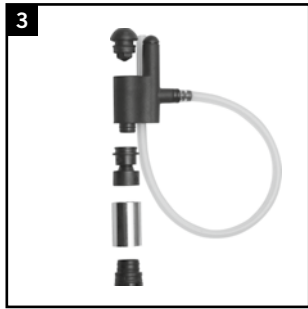

Display symbols



S1 Water tank



S2 Drip tray



S3 Aroma



S4 Lid of coffee powder chute



S5 Two cups



S6 Filter



S7 Descaling



S8 Automatic switch-off



S9 Temperature



S10 Rinsing



S11 Cleaning



S12 Steam valve

— — — S13 Bar

Dear Customer,

Congratulations and thank you very much for choosing a quality product by NIVONA.

In order to enjoy your new NIVONA appliance to its best, please read this manual and pay attention to the safety tips before first use.

Please keep this manual safe. You can use it for references and hand it over to a future owner.

Enjoy your coffee and the top quality appliance by NIVONA.

Purchased at

Location, date

1. SAFETY INFORMATION	29
2. INITIAL START-UP	30
2.1 Getting started	30
2.2 The most important controls	31
2.3 Filling with water and beans	31
2.4 Switching appliance on and filling the system	31
2.5 Using the appliance with filter	32
2.6 Using the device without filter, adjust water hardness	32
2.7 Set automatic switch-off time	33
2.8 Adjusting the temperature	33
2.9 Setting the automatic off-rinsing process	34
2.10 Adjusting the coarseness of the grinding	34
2.11 Reset to factory settings	34
3. MAKING COFFEE	35
3.1 Switching the appliance on	35
3.2 Switching the appliance on	35
3.3 Select water volume	35
3.4 Making a cup of coffee	35
3.5 Making two cups of coffee	36
3.6 Making ground coffee	36
3.7 Making hot water (e.g. for tea)	36
3.8 Frothing milk and making cappuccino	37
4. CLEANING AND MAINTENANCE	37
4.1 Changing the filter	38
4.2 System cleaning	38
4.3 Descaling	39
4.4 Regular cleaning by hand	40
4.5 Cleaning the brew unit	41
5. SYSTEM REPORTS	42
6. PROBLEM SOLVING	43
7. REPLACEMENT PARTS/ACCESSORIES	44
8. CUSTOMER SERVICE, GUARANTEE, ENVIRONMENTAL PROTECTION	44
9. TECHNICAL DATA	45

1. Safety information

- This appliance may only be used for the intended purpose (domestic use only). It is not intended for commercial use (see guarantee). Warranty claims will become void if this appliance is used for other than its intended purpose.
- It is imperative that appliance voltage and mains voltage are identical. Please check the type label/sticker on the appliance (see fig. 1/S).
- Do not use the appliance if the power cable or the casing is damaged. The power cable must never come into contact with any hot surfaces.
- Always pull the plug, not the power cable, when unplugging the appliance from the wall socket.
- Please adhere to the cleaning and decalcifying instructions at all times! Non-compliance will render warranty claims void.
- Please make sure that the appliance is switched off and the mains plug pulled before maintenance and cleaning.
- Place the appliance on a flat and stable surface and only use it indoors. Never place the appliance on hot surfaces or near an open fire.
- This appliance may be used by **children** from the age of eight as well as by persons with reduced physical, sensory or mental capabilities, or lack of experience and knowledge, as long as they are being supervised or have been given instructions for the use of the appliance, hence understanding the possible dangers. **Children** must not play with the appliance. Cleaning and **user maintenance** must not be undertaken by children without supervision. The appliance and its mains connections must be kept away from children under the age of eight.
- Unplug from mains if you are away for a few days.
- Do not leave the appliance on unnecessarily. Never immerse the appliance in water.
- Do not put the appliance or any of its parts in the dishwasher. Non-compliance will render warranty claims void.
- If the appliance shows any defect, pull the plug immediately (never tug at the mains cable or the appliance itself).
- Possible damages caused by incorrect, improper use or unqualified repair works will not be subject to liability. In these cases warranty claims become void.

- Please use the integrated coffee grinder for roasted and untreated beans only, never for other foodstuffs! Please make sure there are no foreign substances among the coffee beans - failing this warranty claims will become void.
- If a repair is necessary (including replacement of the power cable), please first contact the central telephone or email (info@nivona.com) support or the retailer where you bought the appliance – upon consultation and in accordance with item 8 of this manual send the appliance to **NIVONA Zentralkundendienst, Südwestpark 90, D-90449 Nürnberg**
- If the appliance's power cable is damaged, it must be replaced by the manufacturer, its customer service or a similarly qualified person to avoid danger.

⚠ Attention: Repairs to electrical appliances must only be undertaken by a professional! Improper repairs may result in severe danger for the user! Should the appliance be used or maintained improperly or incorrect, the warranty shall become void!

⚠ Attention: Using the on/off switch (fig.1/J) during the brewing process may damage the appliance! Turn the appliance off only after it has finished the job.

⚠ Attention: risk of burning! When drawing steam or hot water, a shot of hot water may spray from the steam/hot water jet or the Spumatore (fig. 1/L); allow the coffee spout, the steam/hot water jet and the Spumatore to cool down before you touch it.

CE – This appliance conforms to valid EG regulations.

2. Initial start-up

(Please read this and follow instructions before you brew your first coffee!)

2.1 Getting started

→ Unpack the appliance and all items belonging to it with care.

The following are included in the package contents:

- User Manual
- Warranty card
- Measuring spoon with assembly instruction for filter insert
- Two cleaning tabs
- One Claris filter
- One testing strip for water hardness

i Tip: In case of customer service being required, the appliance should be shipped in its original packaging. Please keep this safe, including the polystyrene parts.

- Place the appliance on a flat, dry and suitable surface.
- Plug the power cord into a professionally installed mains socket.

→ Your appliance has a power cord bay – if the cable is too long, place the excessive length in the power cord bay at the back (fig. 1/T)

2.2 The most important controls

Before you set the basic settings and brew your first coffee, please make yourself familiar with the main controls of your appliance.

- **On/off switch** (fig. 1/J): Press once to switch the appliance on, press twice to turn it off.
- **Aroma/volume selector** (fig. 1/B): By repeatedly pressing the bean symbol the aroma changes from mild (one bean in display) to normal (two beans) to strong (three beans); restart again with mild. By turning clockwise, the volume per cup is increased, by turning anti-clockwise it is reduced.
- **Steam/hot water control** (fig. 1/C): Place a cup under the steam/hot water jet/Spumatore (fig. 1/L). By turning the knob all the way clockwise you open the valve for steam or hot water. Turning it anti-clockwise closes the valve.
- **Coffee button** (Bild 1/D): (fig. 1/D): Before pressing the button, place one or two cups under the height adjustable spout (fig. 7 and 8). By pressing once you will get one cup, two cups by pressing twice in quick succession.
- **Steam/rinsing button** (fig. 1/E): When the symbol S10 **S** lights up, press the button to start the rinsing process. If the symbol S10 **S** does not show, press to start the heating-up process to steam temperature. Holding the button for more than 3 seconds you enter the menu for the basic settings. Press the button again for more than 3 seconds to leave the menu.
- **Height adjustable spout**: By pushing up or down you can adjust the drain to the height of your cups or glasses.

2.3 Filling with water and beans

- Open the cover on the left (fig. 1/F) and remove the water tank (fig.4). Clean it with clear, cold tap water.
- Refill the water tank to maximum and insert it back in the appliance. Make sure the tank is safely locked in place.

⚠ Attention: Only use clear, cold water for the water tank! Never use sparkling water or any other liquids! Non-compliance will render warranty claims void.

→ Open the bean container's cover on the right (fig. 1/H). Fill with untreated, roasted coffee beans only (fig.5) and close again.

⚠ Attention: Never use beans that have been treated during or after roasting with supplements like sugar or similar. This may cause damages to the mill. Resulting repairs are not covered by the warranty.

2.4 Switching appliance on and filling the system

i Tip: For production reasons the internal pipes may be empty when setting the appliance up for the first time. The appliance will show this as follows: the symbol S12  will display when the mains are connected and the ON/OFF switch (fig. 1/J) has been pushed.

- Connect the mains plug to a professionally installed socket.
- Switch the appliance on with the on/off switch (fig. 1/J).

After a short while the symbol S12  will show up in display.

→ Place a sufficiently large bowl (minimum contents 0.5 l) under the steam/hot water jet/ Spumatore (fig. 1/L) and turn the steam/hot water control (fig. 1/C) clockwise all the way.

The system is now being filled with water and cleaned through the steam/hot water spout/Spumatore. This process will finish automatically.

→ Afterwards turn the steam/hot water knob (fig. 1/C) anti-clockwise all the way to close.

Symbol S10 **S** will now appear.

→ Press steam/rinsing button (fig. 1/E).

Your appliance is now ready for use.

2.5 Using the appliance *with* filter

It is up to you whether you would like to use the appliance with or without filter.

A Claris filter is included in the delivery. Using this filter, the appliance needs descaling less often because the filter softens the water. Ex factory the setting is “no filter”.

→ Empty the water tank (fig. 4) and carefully screw in the filter into the respective slot in the water tank, using the integrated tool at the end of the measuring spoon (fig. 6).

⚠ Attention: Do not overtighten or break.

→ Fill the tank with fresh water and insert it back in the appliance.

→ Press steam/rinsing button (fig. 1/E) for more than 3 seconds to go to main menu.

Symbol S7  and up to 4 bars light up at the bottom of the display.

→ Press coffee button (fig. 1/D) until symbol S6  appears, to make the appliance recognize that the filter has been installed.

→ Press steam/rinsing button (fig. 1/E) to confirm your choice.

Symbol S6  flashes on the display and symbol S12  is on.

→ Place a sufficiently large bowl (minimum contents 0.5 l) under the steam/hot water jet/Spumatore (fig. 1/L) and turn the steam/hot water control (fig. 1/C) clockwise all the way.

The system is now being flushed. Symbol S6  flashes on the display.

→ Wait until no more water is dispersed from the steam/hot water jet /Spumatore.

The display shows symbol S12 .

→ Turn the steam/hot water control (fig. 1/C) back anti-clockwise all the way.

Depending on the presets, one, two or three beans are shown in the display. The appliance is now ready for use.

i Tip: If you are using a filter, the internal water softening is automatically set to water hardness level 1! The appliance needs descaling less frequently – but always descale when called upon to do so and always with the FILTER REMOVED.

The filter will be flat after approx. 50 l of water have been drawn (see chapter 4.1. how to change the filter).

⚠ Attention: Even if the display does not indicate “Change filter” by highlighting the symbol , the filter needs changing after a maximum of two months if the appliance is not used regularly (see chapter 4).

2.6 Using the device *without* filter, adjust water hardness

Depending on the water hardness in your area, the appliance needs to be descaled every now and again. For the system to be able to indicate that this is necessary, you need to set the correct water hardness **prior to first use**.

Using the appliance with the filter and the appropriate settings (see above) the water hardness is automatically set to level 1.

First test the water quality with the enclosed test strip.

→ Dip the test strip into the water and shake it lightly.

→ After about one minute you will be able to read the result by counting the red dots on the test strip.

→ The different levels are listed as follows and can be adjusted:

Test strip / Degree of hardness = Display

1 red dot / 1–7° = LEVEL 1 = 1 red bar

2 red dots / 8–14° = LEVEL 2 = 2 red bars

3 red dots/ 15–21° = LEVEL 3 = 3 red bars

4 red dots / >21° = LEVEL 4 = 4 red bars



i Tip: If the test strip does not show any red dot, please set up level 1.

⚠ Attention: Should you want to use the appliance without filter, the water hardness must be set. This is important because depending on the water hardness the appliance needs to be descaled more often (ex factory the appliance comes with the setting “use without filter; level 3 water hardness”!).

→ Press steam/rinsing button (fig. 1/E) for more than 3 seconds to go to main menu.

Symbol S7  and up to 3 bars light up at the bottom of the display.

→ By pressing the coffee button (fig. 1/D) repeatedly the number of bars at the bottom of the display increases one bar at a time. Set the level for your water hardness in accordance with the number of bars.

→ Press steam/rinsing button (fig. 1/E) to confirm your choice. Symbol S13  flashes on the display and symbol S7  is on.

→ Press steam/rinsing button (fig. 1/E) for more than 3 seconds to leave the main menu.

Depending on the presets, one, two or three beans are shown in the display. The appliance is now ready for use.

2.7 Set automatic switch-off time

This function allows you to determine the automatic switch-off time after the last use. The ex factory setting is “after 5 minutes”.

→ Press steam/rinsing button (fig. 1/E) for more than 3 seconds to go to main menu. Release button.

→ Press steam/rinsing button (fig. 1/E) repeatedly until symbol S8  appears.

→ To change the switch-off time press the coffee button (fig. 1/D) repeatedly.

In doing so you increase the number of bars at the bottom of the display one bar at a time according to your personal preference:

1 bar = automatic switch-off time after 5 minutes

2 bars = automatic switch-off time after 30 minutes

3 bars = automatic switch-off time after 70 minutes

→ Press steam/rinsing button (fig. 1/E) to confirm your choice. The bars will light up briefly.

→ Press steam/rinsing button (fig. 1/E) for more than 3 seconds to leave the main menu.

Depending on the presets, one, two or three beans are shown in the display. The appliance is now ready for use.

2.8 Adjusting the temperature

You can adjust the temperature as required to “normal”, “high” or maximum”. The ex factory setting is “high”.

→ Press steam/rinsing button (fig. 1/E) for more than 3 seconds to go to main menu. Release button.

→ Press steam/rinsing button (fig. 1/E) repeatedly until symbol S9  appears.

→ To change the temperature press coffee button (fig. 1/D) repeatedly.

In doing so you increase the number of bars at the bottom of the display one bar at a time. Set the level for your preferred temperature in accordance with the number of red bars. The bars read as follows:

1 bar = temperature “normal“

2 bars = temperature “high“

3 bars = temperature “maximum“

After 3 bars the display starts again with one bar.

→ Press steam/rinsing button (fig. 1/E) to confirm your choice. The bars will light up briefly.

→ Press steam/rinsing button (fig. 1/E) for more than 3 seconds to leave the main menu.

Depending on the presets, one, two or three beans are shown in the display. The appliance is now ready for use.

2.9 Setting the automatic off-rinsing process

Optionally you can activate the automatic off-rinsing process for additional hygiene after the appliance has been switched off.

The ex factory setting is "off".

- Press steam/rinsing button (fig. 1/E) for more than 3 seconds to go to main menu.
- Press steam/rinsing button (fig. 1/E) repeatedly until symbol S10 **S** appears.
- To change the setting press the coffee button (fig.1/D) repeatedly.

In doing so you increase the number of bars at the bottom of the display one bar at a time. Set the level for your preferred temperature in accordance with the number of red bars:

- 1 bar = automatic off-rinsing „off“
- 2 bars = automatic off-rinsing „on“

After 2 bars the display starts again with one bar.

- Press steam/rinsing button (fig. 1/E) to confirm your choice. The bars will light up briefly.
- Press steam/rinsing button (fig. 1/E) for more than 3 seconds to leave the main menu.

Depending on the presets, one, two or three beans are shown in the display. The appliance is now ready for use.

2.10 Adjusting the coarseness of the grinding

⚠ Attention: Only adjust the grinding coarseness whilst the grinder is running.

You can adjust the grinder according to the particular blend of bean. We suggest the grinder is kept on a medium setting.

To change the coarseness of the grinding, please follow these steps:

- Open the service door on the right of the casing (fig. 1/M).

The grinding coarseness control is at the top right (fig. 11).

- Place a cup under the coffee spout.
- Press the coffee button (fig. 1/D).
- While the grinder is grinding, change the coarseness of grinding by moving the control (fig. 11).

The smaller the dot, the finer the coffee powder. Please note:

- A light roast level needs finer grinding adjustment (control further to the left).
- A dark roast level requires coarser grinding adjustment (control further to the right).

Check out for yourself the best setting according to your personal taste.

- Close the service door gently and in doing so carefully place the pivots at the back of the service door into the notches. Make sure that the door completely snaps back into place.

2.11 Reset to factory settings

To reset the factory settings proceed as follows:

- Switch the appliance on.
- Press steam/rinsing button (fig. 1/E) and coffee button (fig. 1/D) simultaneously for more than 3 seconds.
- All red bars will light up briefly.

The factory setting has been reset.

3. Making coffee

i **Tip: Ex factory the appliance is set so that you can brew your first coffee straightaway. But we do recommend to make the necessary adjustments according to your personal preferences. Hence check chapter 2 "Getting started" first and follow its instructions!**

i **Tip: When you use the appliance for the first time or if it hasn't been used for a prolonged period of time the first cup will not have the full aroma and should therefore not be consumed.**

3.1 Switching the appliance on

Once you have completed the instructions (chapter 2), the procedure for switching the appliance on is always similar:

- Switch on using the on/off switch (fig. 1/J).

The display shows 5 flashing red bars. When the system has reached its operating temperature, the display will show symbol S10 **S**.

- Press steam/rinsing button (fig. 1/E).

The system is now being rinsed. The appliance is now ready for use. Depending on the presets, one, two or three beans are shown in the display.

i **Tip: if you do not use the appliance for a prolonged period of time (e.g. holidays), switch it off using the on/off switch (fig. 1/J) and pull the mains plug.**

3.2 Selecting the coffee strength

The coffee strength can be set in three levels according to taste which the display will show:

MILD, the display features one bean, about 7 grams of ground coffee, e.g. for latte or cappuccino;
STANDARD, the display features two beans, about 9 grams of ground coffee, e.g. for coffee;
STRONG, the display features three beans, about 11 grams of ground coffee, e.g. for espresso or strong coffee.

As soon as the appliance is operational, the display will show either its latest preset or the ex factory setting.

- You can change the setting by repeatedly pressing the aroma/volume selector (fig. 1/B). Thus the aroma changes from mild (one bean in display) to standard (two beans in display) to strong (three beans in display) and back to mild.

3.3 Select water volume

- By turning the aroma/volume selector (fig. 1/B), you can smoothly adjust the amount of water (cup symbol bottom left for little water, full cup symbol bottom right for plenty of water).

3.4 Making a cup of coffee

Once you've chosen coffee strength (see chapter 3.2) and water volume (see chapter 3.3),

- place a cup centrally beneath the spout (fig. 7).

The spout is adjustable in height to match the size of the cup.

- Press the coffee button briefly (fig. 1/D).

The appliance will now start grinding, pre-brewing and brewing.

The process can be aborted any time by pressing the coffee button again.

⚠ Attention: When making your first coffee, the grinder box is still empty. It can therefore happen that the symbol S3 000 will flash after the first grinding and the appliance will not make any coffee.

- In this case simply press the coffee button again (fig. 1/D).

👍 Tip: The water volume can be adjusted while making coffee. Check out for yourself the best setting according to your personal taste and the size of the cup.

 **Tip:** To remember the ideal setting for your personal taste, proceed as follows:

→ Turn the aroma/volume selector (fig. 1/B) to the following positions:

- a small espresso cup to the centre,
- a large cup to the far right.

→ Press the coffee button (fig. 1/D).

The appliance will now start making coffee.

→ Shortly before the set amount of coffee is ready, turn the aroma/volume selector (fig. 1/B) slowly to the left until the appliance stops working.

Make a note of the aroma/volume selector's position for the size of the coffee cup.

3.5 Making two cups of coffee

Once you've chosen coffee strength (see chapter 3.2) and water volume (see chapter 3.3),

→ place two cups beneath the spout (fig. 8).

The spout is adjustable in height to match the size of the cups.

→ Press the coffee button twice in succession (fig. 1/D).

The display will show symbol S5 .

The appliance will now start grinding, pre-brewing and brewing.

The process can be aborted any time by pressing the coffee button (fig. 1/D) again.

When making two cups the grinder will automatically do two rounds.

 **Attention:** When making your first coffee, the grinder box is still empty. It can therefore happen that the symbol S3  will flash after the first grinding and the appliance will not make any coffee.

→ In this case simply press the coffee button again (fig. 1/D).

 **Tip:** In case there is not enough water or the bean container runs out during the two grinding cycles or the trays need emptying, the respective symbols will show on the display. In that case the second cup will not be brewed. Follow the display and press the coffee button (fig. 1/D) again for the second cup.

3.6 Making ground coffee

→ Turn the aroma/volume selector (fig. 1/B) to the water volume required for one cup.

→ Open the lid of coffee powder chute (fig. 1/N). Symbol S4  blinks.

→ Pour in one level measuring spoon of ground coffee and close the lid.

Symbol S4  is flashing.

→ Place one or two cups under the coffee spout (fig. 7 or 8) and press the coffee button (fig. 1/D) once or twice respectively.

The appliance will now start pre-brewing and brewing – without grinding.

 **Tip:** If you have opened the lid of coffee powder chute accidentally or did not press the coffee button after having poured in the ground coffee, the appliance will automatically start rinsing for a minute once the lid is closed. The appliance will then be operational again.

 **Attention:** The coffee powder chute is not a storage container. Therefore never pour in more than one portion of coffee and only use fresh or vacuum-packed coffee ground from coffee beans. Do not use water-soluble instant coffee!

3.7 Making hot water (e.g. for tea)

→ Hold a cup under the steam/hot water jet /Spumatore (fig. 1/L).

→ Turn the steam/hot water control (fig. 1/C) clockwise.

→ Fill the cup with the required water and turn the knob back anti-clockwise to position 0.

 **Danger:** Risk of scalding! Escaping water may spray! The steam/hot water jet /the Spumatore becomes very hot when used. Let the steam/hot water jet /the Spumatore cool down for a few minutes before touching it. Only touch the rubber parts.

 **Tip:** You can draw hot water for about 2 minutes, after that the appliance will automatically shut down. By turning the steam/hot water control (fig. 1/C) backwards and forwards, you can re-start the process.

3.8 Frothing milk and making cappuccino

The special Spumatore frothing aid (fig. 1/L) can froth milk directly into the cup from a container.

→ Immerse the suction hose (fig. 9 and 10) into the milk (in the container or directly into the milk carton).

→ Place a cup under the Spumatore.

→ Press steam/rinsing button (fig. 1/E).

Whilst heating-up 5 red bars will flash at the bottom of the display. As soon as symbol S12  shows, you can draw steam and froth milk.

 **Attention:** A small amount of water will initially precede the milk froth.

→ Fill the cup with the required amount of milk froth and turn the steam/hot water knob (fig. 1/C) back anti-clockwise to position 0.

→ Wait for the last milk drops before placing the cup under the coffee spout.

→ Press the steam/rinsing button (fig. 1/E) once again.

The appliance is now back to coffee mode.

→ Place the cup with the frothed milk under the coffee spout (fig. 7) and fill up with the required amount of coffee as described in chapter 3.4.

 **Tip:** You can draw hot steam for about 2 minutes, after that the appliance will automatically shut down. By turning the steam/hot water knob (fig. 1/C) back and forth, you can re-start the process.

 **Attention:** Dried milk residue on the steam/hot water jet is difficult to remove. Clean immediately after it has cooled off!

→ To do this fill a bowl with clean water and immerse the suction hose in it.

→ Place an empty bowl under the Spumatore (fig. 1/L).

→ Press steam/rinsing button (fig. 1/E).

Whilst heating-up 5 red bars will flash at the bottom of the display. As soon as symbol S12  shows, you can draw steam.

→ Turn the steam/hot water control (fig. 1/C) clockwise.

 **Attention:** A small amount of water will initially precede the steam.

→ Draw water until only clean water/steam emerges.

→ Turn the steam/hot water control (fig. 1/C) anti-clockwise back to position 0.

→ Press the steam/rinsing button (fig. 1/E) once again.

The appliance is now back to coffee mode.

 **Attention:** From time to time (ideally each time the appliance will not be used for a while, at any rate in regular intervals!) the Spumatore needs to be completely dismantled (fig. 3) and thoroughly cleaned under running water.

4. Cleaning and maintenance



 **Attention:** If your appliance needs cleaning or maintenance, the display will show the respective symbol. Please always follow these instructions, otherwise your warranty will be void. Read chapters 4.1 to 4.5 for further information. Should you wish to maintain or clean your device without being asked to do so, please also follow the instructions in chapters 4.1 to 4.5.

4.1 Changing the filter

The filter will be flat after about 50 l of water have been drawn. The display shows symbol S6 . You can still make coffee, but we recommend to always change the filter immediately.

! Attention: The filter needs changing after a maximum of two months if the appliance is not in regular use. The display will show no status signal. Use the dial (by the month) at the top of the filter to select the date of change.

- Switch the appliance on.
- Press the aroma/volume selector (fig. 1/B) for more than 3 seconds to go to the maintenance menu.

Symbol S6 , S7  or S11  will show up.

- Turn the aroma/volume selector (fig. 1/B) clockwise and anti-clockwise until symbol S6  shows in display.
- Empty the water tank (fig. 4) and unscrew the filter, using the integrated tool at the end of the measuring spoon. Discard the filter.
- Set the dial (by the month) at the top of the new filter to either the date when the filter was installed or the filter needs replacing.
- Screw in the filter into the dedicated slot in the water tank, using the integrated tool at the end of the measuring spoon (fig. 6).
- Fill the tank with fresh water and insert it back in the appliance.
- Place a sufficiently large bowl (minimum contents 0.5 l) under the steam/hot water jet/ Spumatore (fig. 1/L).
- Press the aroma/volume selector (fig. 1/B).

Symbol S6  flashes on the display and symbol S12  is on.

- Turn the steam/hot water knob (fig. 1/C) clockwise all the way.

The system is now being flushed.

- Wait until no more water is dispersed from the jet and turn the control (fig. 1/C) back anti-clockwise to close.

The device will heat up briefly and is ready for use again.

4.2 System cleaning

If the device needs cleaning, the display will show symbol S11 .

i Tip: You can continue making coffee or draw hot water and steam, but we recommend to start the cleaning program as soon as possible. Otherwise the function might be impaired and your warranty could be compromised.



! Attention: Do not disrupt the cleaning process. Follow the instructions exactly in the stated order. Insert cleaning tab only if the appliance asks for it.

i Tip: During the cleaning process the red bars at the bottom of the display will show the progress. The more bars that are visible, the further the program has advanced.

- Switch the appliance on.
- Press the aroma/volume selector (fig. 1/B) for more than 3 seconds to go to the maintenance menu.

Symbol S6 , S7  or S11  will be on.

- Turn the aroma/volume selector (fig. 1/B) clockwise and anti-clockwise until symbol S11  shows in display.
- Start the cleaning process by briefly pressing the aroma/volume selector (fig. 1/B).

Symbol S11  flashes on the display, symbols S1  and Symbol S2  are on.



- Remove the water tank (fig.4) and fill it to maximum. Reinsert the water tank.
- Remove drip tray with used coffee container (fig. 1/O and P) and empty both.
- Reinsert drip tray and used coffee container.

The appliance starts cleaning. When finished symbol S4  will additionally show.

- Place a sufficiently large bowl (about 0.5 l) under the coffee spout.
- Open the lid of coffee powder chute (fig. 1/N).

Symbol S4  flashes to indicate that the cleaning tab should be inserted.

- Place a cleaning tab in the coffee powder chute and close the lid,

The cleaning process starts. Symbol S11  flashes. The cleaning process is automatic and will run for about 10 minutes. Once the process has finished, symbol S2  is on and symbol S11  flashes.

- Remove drip tray with used coffee container (fig. 1/O and P) and empty both.
- Reinsert drip tray and used coffee container.

The appliance briefly heats up. It is ready for use again when the bean symbols in the display are on.

Manual cleaning

If required the cleaning program can also be started and run as described in chapter 4.2, without the prompt of symbol S11 .

4.3 Descaling

If the appliance needs descaling, symbol S7  appears on the display.



i Tip: You can continue making coffee or draw hot water and steam, but we recommend to start the descaling program as soon as possible. Otherwise the function might be impaired and your warranty could be compromised.

! Attention: Do not disrupt the descaling program. Follow the instructions exactly in the stated order. Never use vinegar or vinegar-based agents, only standard liquid products specifically recommended for automatic coffee machines.



! Attention: Before starting the descaling program remove the filter from the water tank.

i Tip: During the descaling program the progress is displayed through the red bars at the bottom of the display. The more bars are shown the further the progress.



- Switch the appliance on.
- Press the aroma/volume selector (fig. 1/B) for more than 3 seconds to go to the maintenance menu.

Symbol S6 , S7  or S11  will be on.

- Turn the aroma/volume selector (fig.1/B) clockwise and anti-clockwise until symbol S7  is on.
- Start the descaling program by briefly pressing the aroma/volume selector (fig. 1/B).

Symbol S7  flashes, symbol S2  is on.

- Remove drip tray with used coffee container (fig. 1/O and P) and empty both.
- Reinsert drip tray and used coffee container.



Symbol S1  is on, while symbol S7  continues to flash.

- Remove water tank (fig. 4).
- Remove filter if one is fitted (fig. 4).
- Fill the water tank to its 0,5 l mark with fresh water.
- Reinsert the water tank.



Symbol S12  is on.

- **Only then** add descaling agent (never vice versa! Please follow the manufacturers' advice for use of the descaler!).

- Place a sufficiently large bowl (about 0.5 l) under the steam/hot water jet/Spumatore.
- Turn the steam/hot water control (fig. 1/C) clockwise.

The descaling program starts. Symbol S7  flashes. The descaling process is automatic and will run for about 10 minutes. As soon as the first part of the program has finished, symbol S12  is on and symbol S7  flashes.

- Turn the steam/hot water selector (fig. 1/C) anti-clockwise.

The descaling program starts again, the descaler runs into the drip tray. Symbol S7  flashes. The descaling process is automatic and will again run for about 10 minutes. Once the process has finished, symbol S2  is on and symbol S7  flashes.

- Remove drip tray with used coffee container (fig. 1/O and P). Empty and clean both.
- Reinsert drip tray and used coffee container.



Symbol S1  is on.



- Remove water tank and rinse it with fresh water.
- Reinsert filter if required.
- Fill the water tank with fresh water.
- Reinsert the water tank.

Symbol S12  is on.

- Again place a sufficiently large bowl (about 0.5 l) under the steam/hot water jet/Spumatore.
- Turn the steam/hot water control (fig. 1/C) clockwise.

The rinsing process through the steam/hot water jet /Spumatore starts.

- Once the process has finished, symbol S7  flashes and symbol S12  is on.
- Turn the steam/hot water control (fig. 1/C) anti-clockwise.

The internal rinsing program starts and will take about one minute, followed by a brief rinsing of the coffee spout. The symbol S7  flashes and symbol S2  is on.

- Remove drip tray with used coffee container (fig. 1/O and P) and empty both.
- Reinsert drip tray and used coffee container.

The appliance briefly heats up. It is ready for use again when the bean symbols in the display are on.

⚠ Attention: Please remove any descaler residues on the casing immediately with a damp cloth.

Manual descaling

If required the descaling program can also be started and run as described above, without the prompt of symbol S7 .

4.4 Regular cleaning by hand

i Tip: Please follow these cleaning instructions as working with foodstuffs demands the highest degree of cleanliness.

⚠ Attention: Never immerse the appliance in water! Do not use abrasive cleaning agents.

- Empty drip tray and used coffee container regularly (fig. 1/O and P). The red floating indicator at the back of the drip tray (fig. 1/Q) shows the tray's filling level.
- Only use a soft, damp cloth for cleaning the casing inside and outside.
- Empty drip tray and used coffee container (fig. 1/O and P) at the latest when this is indicated on the display (only when the appliance is switched on!).

Occasionally use a little soapy water for cleaning.

- The water tank should be rinsed daily with clear water and then re-filled daily with fresh cool water.

i TIP: Dried milk residue is difficult to remove.

- Therefore clean the steam/hot water jet/Spumatore, the suction hose regularly.

⚠ Attention: From time to time (ideally each time the appliance will not be used for a while, at any rate in regular intervals!) the steam/hot water jet needs to be completely dismantled and thoroughly cleaned under running water (fig.3). We recommend our special cleaning agent for milk residue NICC 705.









4.5 Cleaning the brew unit

⚠ Attention: Remove the brew unit only when the appliance is switched off.

When necessary the brew unit can be removed and cleaned under cold, running water. Never use any cleaning agent, but clear, cold water only! For hygienic reasons we recommend the removal and cleaning of the unit thoroughly after each run of the cleaning program (see chapter 4.2).

- Open and remove the service door on the right of the casing (fig. 1/M).
- Remove the brew unit by pressing the red switch and turning the handle all the way to the left until it snaps into place (fig. 12).
- Carefully remove the brew unit using the handle.
- Clean the brew unit under running cold water and let it dry.
- Reinsert the brew unit carefully and lock by pressing down the red switch and turning the handle all the way to the right until it snaps into place.
- Close the service door and in doing so carefully place the pivots at the back of the door into the notches. Make sure that the door (fig. 1/M) completely snaps back into place.

5. System reports

Report	Cause	Solution
S3  flashes	No beans	→ Add beans, restart coffee making
S12 	Refill water pipe system Filter possibly defective	→ Turn steam/hot water control clockwise → Remove or replace filter
S1  on	Water tank is empty Water tank is missing or inserted incorrectly	→ Fill water tank → Reinsert water tank
S2  on	Drip tray and/or used coffee container full	→ Empty drip tray and/or used coffee container
S2  flashes	Drip tray with used coffee container missing or fitted incorrectly	→ Reinsert drip tray with used coffee container
S11  on	System cleaning required	→ Clean system (see chapter 4.2)
S7  on	System descaling necessary	→ Descale system (see chapter 4.3)
S6  on	Filter exhausted	→ Change filter (see chapter 4.1)
S13 bar 1 and bar 5 flash alternately	Brew unit fitted incorrectly	→ Fit brew unit correctly and snap into place (see chapter 4.5)

6. Problem solving

Fault	Cause	Solution
No hot water or steam	Blocked steam/hot water jet/ Spumatore (fig.1/L)	→ Dismantle and thoroughly clean steam/hot water jet/ Spumatore (fig.3)
	System may be calcified	→ Please run a high dosage of descaler (see chapter 4.3)
Not enough milk froth or liquid froth	Unsuitable milk	→ Use cold milk
	Blocked steam/hot water jet / Spumatore	→ Dismantle and thoroughly clean steam/hot water jet/ Spumatore (fig.3)
Coffee only drips	System may be calcified	→ Please run a high dosage of descaler (see chapter 4.3)
	Coffee is too finely ground	→ Set the grinder on a coarser setting
	Coffee powder too fine	→ Change to coarser coffee powder
No “crema” on the coffee	Unsuitable coffee beans	→ Change coffee beans
	Beans may be too old	→ Change to fresh beans
	Grinding coarseness not adjusted to beans	→ Optimize grinding coarseness
Strong noise from coffee grinder	Foreign matter in grinder, e.g. small stones	→ Call service hotline, ground coffee can still be made

In the event of a fault or a system report which you cannot correct yourself, please contact our email (info@nivona.com) or Service-Hotline: 0049 911-25266390

If the system detects any errors, the display will show an error report

- flashing bars or
- lighted bars.

⚠ Attention: Please make a note of the flashing or lit up bars. Switch the appliance off and pull the mains plug. Then call the service hotline 0049-911-25266390 or email (info@nivona.com) us with name type, serial number (see type label, fig.1/S) and error number. Our service team will take care of the next steps.

7. Replacement parts/Accessories

Fresh water filter NIRF 700:

New fresh water filters are available from well-stocked local dealers.

Cleaning tabs NIRT 701:

New cleaning tabs are available from well-stocked local dealers.

Descaling agent NIRK 703:

New descaling agents are available from well-stocked local dealers.

Special milk residue cleaner NICC 705:

Special milk residue cleaner is available from well-stocked local dealers.

MilkCooler NICT 500:

This top-quality stainless steel milk cooler keeps milk „fridge cold“ for a long time and delivers the best frothing results.

MilkContainer NIMC 900:

MilkContainer is made from transparent synthetic material to show the filling level at a glance.

8. Customer service, guarantee, environmental protection

Customer service

Nivona products are manufactured to the highest quality standards. Should any question arise with regards to your appliance, please do not hesitate to write to us. Only with your active support will we be able to improve our products and further develop them, so that they will fully satisfy your demand.

In the event that you need to ship your faulty appliance directly to us, please make sure that no residual water remains in the system:

- Switch the appliance off.
- Press the on/off switch (fig. 1/J) and the steam/rinsing button (fig. 1/E) simultaneously for at least 3 seconds.
- Remove the water tank (fig. 4).
- Place a sufficiently large bowl (minimum contents 0.5 l) under the steam/hot water jet / Spumatore.
- Turn the steam/hot water control (fig. 1/C) clockwise all the way.

The appliance is now steaming off. All 5 red bars are flashing in the display.

- When symbol S12  shows, turn the steam/hot water control (fig.1/C) anti-clockwise.

The appliance will then switch off.

- Remove drip tray with used coffee container (fig. 1/O and 1/P) and empty both.
- Reinsert drip tray and used coffee container.

Your appliance is now ready for shipment.

 **Tip: Please make sure that you pack the appliance very carefully before shipping, ideally in the original packaging. The manufacturer will assume no liabilities for damage in transit.**

Guarantee and customer service terms and conditions

Please find detailed information about guarantee and customer service terms and conditions in the accompanying document.

Please dispose of filters with domestic waste.

Disposal of your old appliance and packaging

Please keep the original packaging. It will serve as protection should you need to ship the appliance in the event of a customer service issue.

Electrical and electronic appliances often contain valuable, but sometimes also environmentally damaging material and should therefore not be disposed of as normal household waste. They may damage human health and harm the environment when wrongfully handled or left among residual waste. Therefore please drop your old or irreparably damaged appliance at your local community waste collection/recycling centre.

Further information is available from the dealer where you bought the appliance, your town hall or waste collector.

9. Technical data

Voltage 220 - 240V AC, 50/60 Hz

Power consumption 1455 W

NIVONA Apparate GmbH
Südwestpark 90
D-90449 Nürnberg
Germany
www.nivona.com
© 2013 by NIVONA